

Industrial 2-port RS422/485 Modbus Gateway



Economical Solution for Industrial Modbus TCP/RTU/ASCII Network Integration

PLANET has added the Industrial Modbus TCP/IP Protocol to its IMG-120T Industrial-level 2-port RS422/485 Modbus Gateway, an industrial management level product that comes with SCADA/HMI system and other data acquisition systems on the factory floor. Moreover, an industrial IT SNMP network can be upgraded to an Industrial automation Modbus TCP/IP network without any difficulty and extra expense. The IMG-120T offers a flexible network connectivity solution for industrial automation environment. PLANET IMG-120T is a conversion bridge between Modbus TCP/IP Protocol and Modbus RTU/ASCII Protocol. It features a wide operating temperature range from -40 to 75 degrees C and a compact but rugged IP40 metal housing.



The Conversion Bridge that Makes Communications Convenient

As the conversion bridge, the IMG-120T communicates well between any industrial equipment with the Modbus RTU/ASCII Protocol and the administrator workstation that runs the Modbus TCP/IP Protocol. The RS422/485 serial interface of the IMG-120T provides the Modbus RTU/ASCII operation mode and various baud rate options to meet the demand of integration between the Modbus TCP/IP Protocol, Modbus RTU Master/Slave Protocol and Modbus ASCII Master/Slave Protocol.

Serial Interface

- Two RS422/485 ports with 5-contact terminal block
- Cost effective for RS422/RS485 to Fast Ethernet 10/100BASE-TX application
- Supports 4-wire RS422 or 2-wire RS485 with 5-contact terminal block
- 300bps~115200bps baud rate and non-blocking communication

Ethernet Interface

- Complies with IEEE 802.3, IEEE 802.3u 10/100BASE-TX standard
- Supports 10/100BASE-TX RJ45 port with distance up to 100m

Management Function

- Built-in IP-based Web interface and telnet interface for remote management
- Software Protocol supports Modbus TCP, Modbus RTU, Modbus ASCII, IP, ARP, DHCP and DNS
- Supports RTU Master, RTU Slave, ASCII Master, and ASCII Slave modes via management interface
- Master mode supports 32 slave TCP connection requests
- Slave mode supports 16 TCP master connections
- Supports IP address and MAC address filtering function
- PLANET Modbus Gateway utility for finding client device on the network and related IP subnet address setting, to reset to factory default function
- PLANET Smart Discovery utility automatically finds the client devices on the network
- Firmware upgrade/configuration backup and restore via HTTP protocol

Hardware

- LED indicators for system, network and RS422/485 port diagnostics
- DIP switch on the upper panel for resetting to factory default
- Wall-mount kit

Industrial Case and Installation

- Wallmount-type IP40 metal case
- The 2-contact terminal block connector on the top panel of Industrial Modbus Gateway is used for DC power input (9-48V)
- -40 to 75 degrees C operating temperature

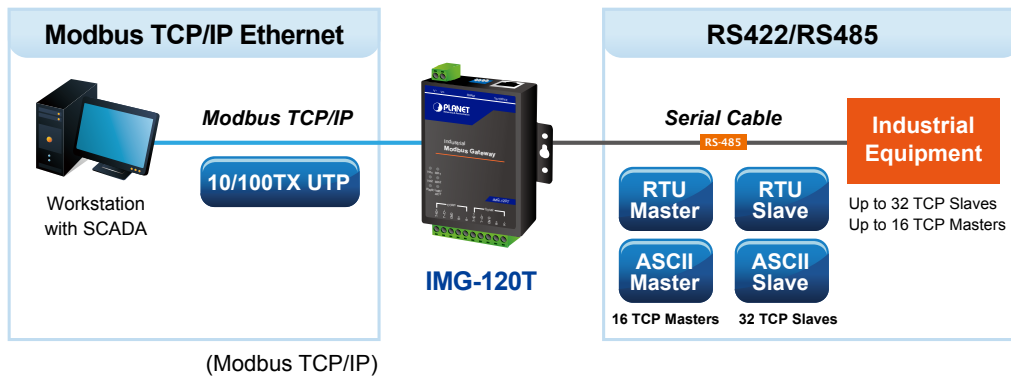

The advantage of having the IMG-120T is to assist users to build an industrial environment between the Modbus TCP/IP Protocol and the Modbus RTU/ASCII Protocol easily, thus offering an application solution to the industrial control equipment without Ethernet ports. Thus, the industrial control equipment can only control through an industrial PC workstation or industrial control panel.

In addition, the effective integration of Modbus Ethernet devices, Modbus serial equipment or multi Modbus master/slave in an industrial hybrid network brings the following:

- Master mode supports up to 32 slave TCP connection requests
- Slave mode supports up to 16 TCP master connections

Remote Management

The IMG-120T makes the connected industrial Modbus RTU/ASCII equipment become IP-based facilities and is able to connect to the Modbus TCP/IP network via its R422/485 serial interface and 10/100BASE-TX RJ45 Ethernet port. It provides a remote web management and telnet Interface for efficient remote network management. The IMG-120T also provides PLANET Modbus Gateway utility tool and supports PLANET Smart Discovery utility to help network administrator to easily get the current IP subnet address information or change the IP subnet address setting of the IMG-120T.

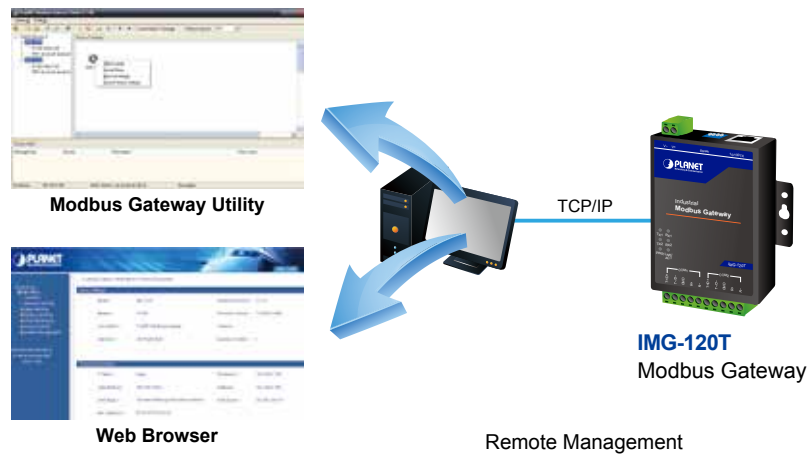

Modbus Serial Port State Monitoring

The IMG-120T shows the details of the total bytes transmitted and received on the RS422/485 serial interface, and the detailed total number of frames transmitted and received on the remote web/telnet management interface. This function allows network administrator to check the status and statistics of the IMG-120T via the single RS422/485 serial interface.

Stable Performance in Hardened Environment Design

The IMG-120T provides a high level of immunity against electromagnetic interference and heavy electrical surges which are usually found on plant floors or in curb-side traffic control cabinets. Its operating temperature ranging from -40 to 75 degrees C allows the IMG-120T to be placed in almost any difficult environment.

The IMG-120T is equipped with a compact IP40-rated metal case that allows wall mounting for efficient use of cabinet space. The IMG-120T also provides an integrated power supply source with wide-ranging voltages (9 to 48V DC) ideally suitable for worldwide operation with high availability applications.

Applications

RTU/ASCII Master to Multi Modbus TCP/IP Slaves

The IMG-120T can act as a bridge between the industrial RTU/ASCII master equipment and the multi-industrial TCP/IP slave equipment in a Modbus TCP/IP networking environment to control multi-industrial TCP/IP slave equipment via the industrial RTU/ASCII master equipment.

RTU/ASCII Master to Multi Modbus TCP/IP Slaves

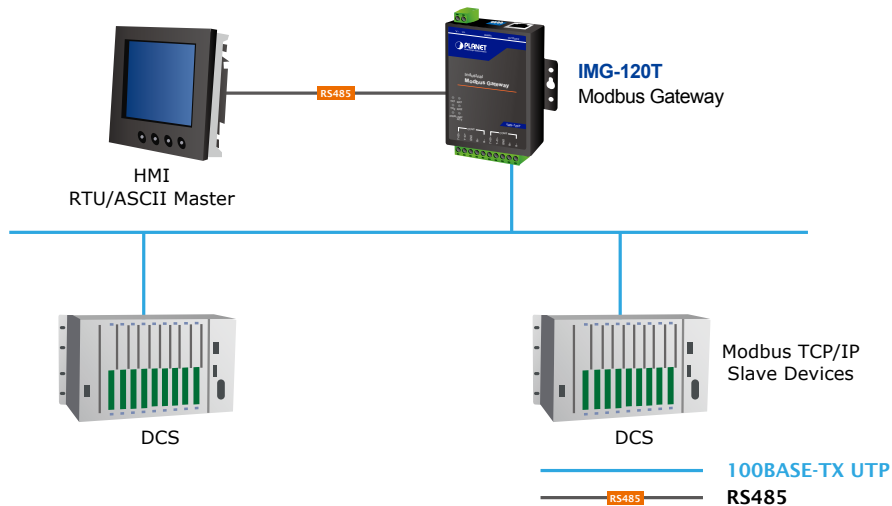

Multi Modbus TCP/IP Master to RTU/ASCII Slaves

The IMG-120T can operate as a bridge between the multi-industrial TCP/IP master equipment and the industrial RTU/ASCII slave equipment in a Modbus TCP/IP networking environment to control the industrial RTU/ASCII slave equipment via the multi-industrial TCP/IP master equipment.

Multi Modbus TCP/IP Master to RTU/ASCII Slaves

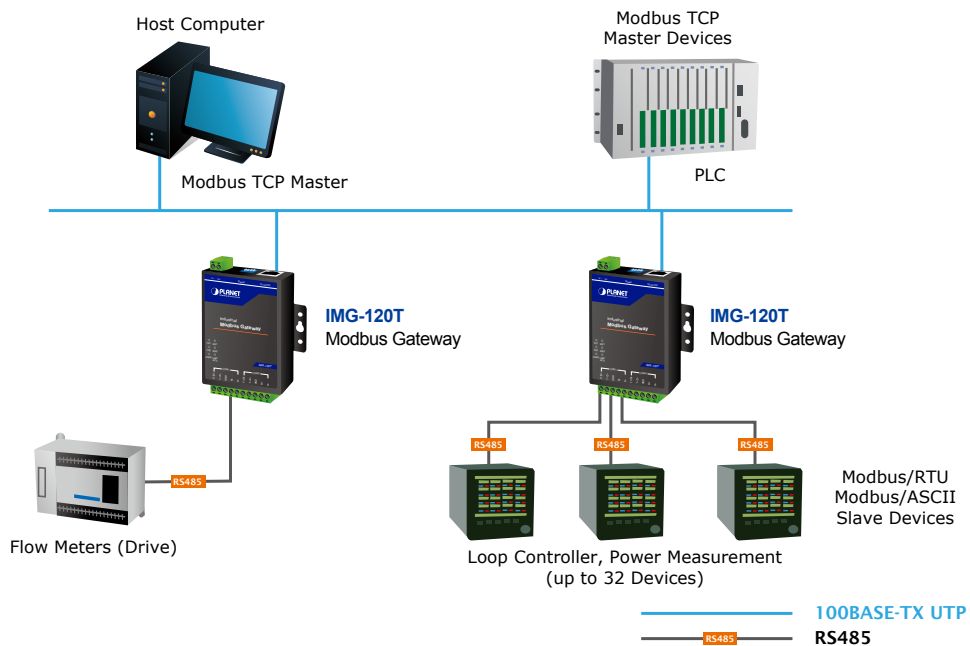

Specifications

Product	IMG-120T
Serial Port	
Interface	RS422/RS485 x 2
Connector	10-contact terminal block for RS422/RS485
Surge Protection	1KV
Baud Rate (Data Rate)	300bps to 115200bps
Data Bits	7, 8
Parity Type	Odd, Even, None, Space, Mark
Stop Bit	1, 2
Flow Control	H/W, None
Signals	RS422: Tx+, Tx-, GND, Rx+, Rx- RS485: Data A (+), GND, Data B (-)
Distance	RS422/RS485 for 20m transfer distance
Operation Mode	RTU Master/RTU Slave/ASCII Master/ASCII Slave Master mode: Supports up to 32 slave TCP connection requests Slave mode: Supports up to 16 TCP master connection requests
Fast Ethernet Port	
Standard	IEEE 802.3 10BASE-T standard IEEE 802.3u 100BASE-TX standard IEEE 802.3x Full-duplex flow control
Connector	RJ45
Distance	100 meters
Hardware	
Copper Port	10/100BASE-TX RJ45 TP x1, auto-MDI/MDI-X, auto-negotiation
Serial Port	RS422/RS485 x 2
DIP Switch	Reset system to factory default
LED Indicators	System: Power x 1 10/100BASE-TX Port: Link/Active x 1 RS422/RS485 Serial Port: TX (Transmit) x 2, RX (Receive) x 2
Management	Remote Web Management Remote Telnet Management PLANET Modbus Gateway Utility PLANET Smart Discovery Utility
Operation Mode	RTU Master RTU Slave ASCII Master ASCII Slave
Dimension (W x D x H)	69 x 100 x 22 mm
Weight	238g
Power Input Connector	2-contact terminal block connector DC power (9-48V) *
Power Consumption	1.25W@9V (max.)
Installation	Wall-mount kit
Mechanical	Metal
Standards Conformance	
Standards Compliance	IEEE 802.3 10BASE-T standard IEEE 802.3u 100BASE-TX standard IEEE 802.3x Full-duplex flow control EIA/TIA RS422/485
Regulatory Compliance	FCC Part 15 Class B, CE
Stability Testing	IEC60068-2-32 (free fall) IEC60068-2-27 (shock) IEC60068-2-6 (vibration)
Environment	
Temperature	Operating: -40~75 degrees C Storage: -40~75 degrees C
Humidity	Operating: 5~95% (non-condensing) Storage: 5~95% (non-condensing)

*: Please follow the DC power input symbol from the front panel of the IMG-120T -- insert positive DC power wire into V+, and negative DC power wire into V-. Otherwise, it will damage the device.

Ordering Information

IMG-120T	Industrial 2-port RS422/485 Modbus Gateway
----------	--

Related Products

IMG-110T	Industrial 1-port RS422/485 Modbus Gateway
ICS-100	RS-232 / RS-422 / RS-485 over Fast Ethernet Media Converter
ICS-2100	Industrial RS-232/ RS-422/ RS-485 over Ethernet Media Converter
PWR-40-24 / PWR-60-24 / PWR-75-24	DC Single Output Industrial DIN Rail Power Supply Units

PLANET Technology Corporation

11F., No.96, Minquan Rd., Xindian Dist., New Taipei City 231,
Taiwan (R.O.C.)

Tel: 886-2-2219-9518

Email: sales@planet.com.tw

Fax: 886-2-2219-9528

www.planet.com.tw



PLANET reserves the right to change specifications without prior notice. All brand names and trademarks are property of their respective owners. Copyright © 2017 PLANET Technology Corp. All rights reserved.

IMG-120T